



ASSEMBLY INSTRUCTIONS

ADIRONDACK CHAIR

(ITEM # 111-C)

DIMENSION OF PACKAGING

300 x 570 x 840mm

COMPONENT LIST

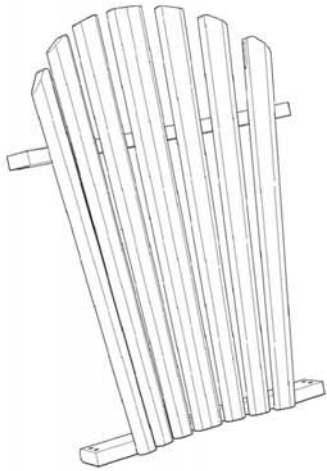

A. BACK SECTION : 1 pcs

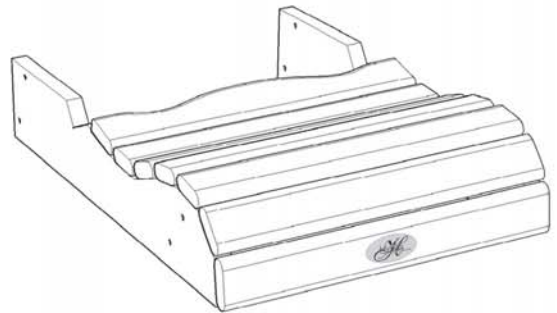

B. SEAT SECTION : 1 pcs

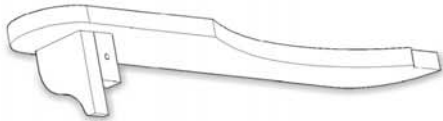

C. ARM REST LEFT : 1 pcs

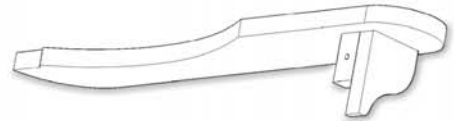

D. ARM REST RIGHT : 1 pcs



E. BACK LEG : 2 pcs



F. FRONT LEG : 2 pcs

HARDWARE LIST

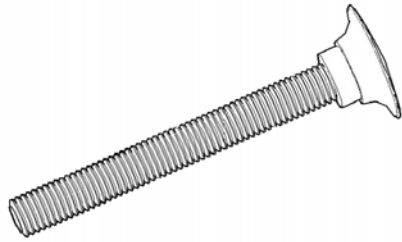

01. BOLT 5/16 x 2.25 inch : 10 pcs



02. SKREW CAP 5/16 inch : 8 pcs

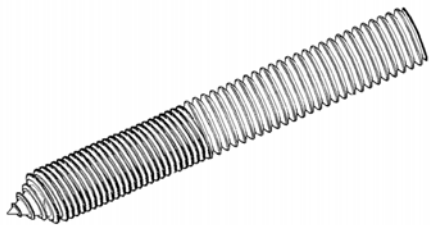

03. BOLT 5/16 x 1.25 inch : 2 pcs

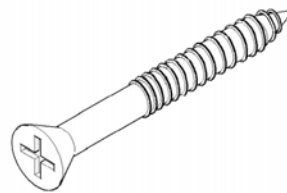

04. SKREW 8M x 1.5 inch : 8 pcs

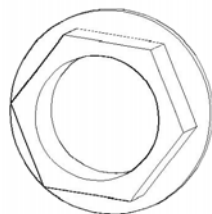

05. FLANGE NUT 5/16 inch : 12 pcs

PART OF PRODUCT

